

PRODUCT SPECIFICATIONS

Elkay Crosstown® 18 Gauge Stainless Steel 22-1/2" x 18-1/2" x 9", Single Bowl Undermount Sink & Faucet Kit with Drain. Sink is manufactured from 18 gauge 304 Stainless Steel with a Polished Satin finish, Rear Center drain placement, and Full spray sides and bottom with Sides and Bottom pads.

Installation Type:	Undermount
Material:	304 Stainless Steel
Finish:	Polished Satin
Gauge:	18
Sound Deadening:	Full spray sides and bottom with Sides and Bottom pads
Number of Bowls:	1
Sink Dimensions:	22-1/2" x 18-1/2" x 9"
Bowl 1 Dimensions:	21" x 17" x 9"
Drain Size:	3-1/2" (89mm)
Drain Location:	Rear Center
Minimum Cabinet Size:	27"
Mounting Hardware:	Included
Template Included:	Yes
Cutout Template #:	1000003457

Template is available for download at [elkay.com](#). CAD software will be required to open the template.



Included with Product: Deep strainer drain LKDD and faucet LKAV3031CR

AMERICAN PRIDE. A LIFETIME TRADITION.
Like your family, the Elkay family has values and traditions that endure. For almost a century, Elkay has been a family-owned and operated company, providing thousands of jobs that support our families and communities.

Product Compliance: ASME A112.19.3/CSA B45.4
Faucet: ASME A112.18.1/CSA B125.1
NSF 61
NSF 372 (lead free)
Accessory: ASME A112.18.2/CSA B125.2

Installation Profile:

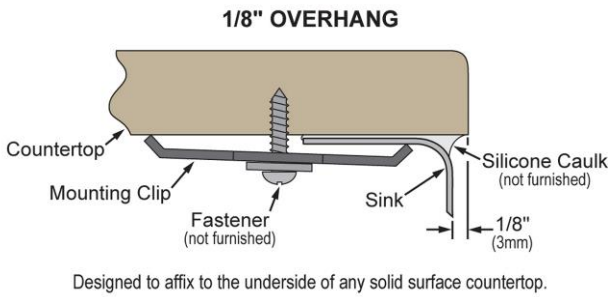

[Clean and Care Manual \(PDF\)](#)
[Installation Instructions \(PDF\) - 1000005239](#)
[Installation Instructions \(PDF\) - 1000005235 drain](#)
[Warranty \(PDF\)](#)

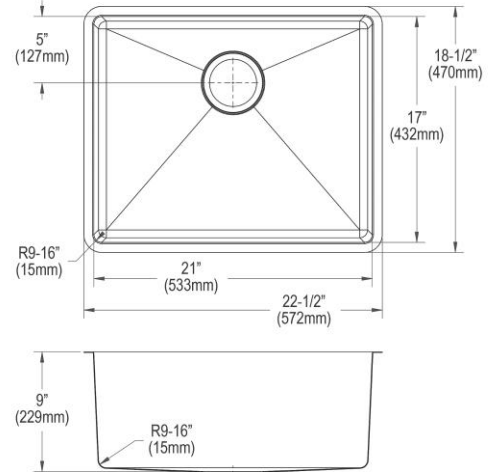

PART: _____ QTY: _____

PROJECT: _____

CONTACT: _____

DATE: _____

NOTES: _____

APPROVAL: _____

In keeping with our policy of continuing product improvement, Elkay reserves the right to change product specifications without notice. Please visit [elkay.com](#) for the most current version of Elkay product specification sheets. This specification describes an Elkay product with design, quality, and functional benefits to the user. When making a comparison of other producers' offerings, be certain these features are not overlooked.

Optional Accessories		
LKDD	Elkay 3-1/2" Drain Fitting Deep Strainer Basket Spec Sheet (PDF)	

In keeping with our policy of continuing product improvement, Elkay reserves the right to change product specifications without notice. Please visit elkay.com for the most current version of Elkay product specification sheets. This specification describes an Elkay product with design, quality, and functional benefits to the user. When making a comparison of other producers' offerings, be certain these features are not overlooked.